

# FORA<sup>®</sup> MD

BLOOD GLUCOSE MONITORING SYSTEM



**Operations & Procedures Manual**

**Long-Term Care**



Thank you for purchasing the **FORA MD** Blood Glucose Monitoring System. This manual provides important information to help you use the system properly. Before using this product, please read the following contents thoroughly and carefully.

If you have other questions regarding this product, please contact the place of purchase or call Customer Service at 1-888-307-8188.

The **FORA MD** is intended for multi-patient use in a long-term care setting. Please note that the following procedures are provided only as a model to help your facility establish its own policy and procedures. Your own policy may differ depending upon the existing procedures. Please consult with the Director of Nursing for further guidance.

**CAUTION:** Please carefully read the User's Manual and all product instructions before using this Long-Term Care and Home Health Care Manual and administering blood glucose tests.

# TABLE OF CONTENTS

<b>IMPORTANT SAFETY PRECAUTIONS</b>	<b>06</b>
Interfering Substances	07
<b>BEFORE YOU BEGIN</b>	<b>08</b>
<b>INTENDED USE</b>	<b>08</b>
<b>TEST PRINCIPLE</b>	<b>08</b>
<b>METER OVERVIEW</b>	<b>09</b>
Display Screen	09
Test Strip	10
Speaking Function	10
Setting the Meter	11
<b>BEFORE TESTING</b>	<b>12</b>
Checking the Code Number	12
Control Solution Testing	13
Performing a Control Solution Test	13
<b>BLOOD GLUCOSE TESTING</b>	<b>14</b>
Preparing the Puncture Site	14
Performing a Blood Glucose Test	15
<b>CLEANING AND DISINFECTION PROCEDURES</b>	<b>16</b>
Caring for Your Meter	16
<b>METER MEMORY</b>	<b>18</b>
Reviewing Test Results	18
Reviewing Blood Glucose Day Average Results	19
<b>MAINTENANCE</b>	<b>19</b>
Battery	19
Replacing the Battery	20
Meter Storage	20
Important Test Strip Information	20
Important Control Solution Information	21

<b>SYSTEM TROUBLESHOOTING</b>	<b>20</b>
Result Readings	20
Error Messages	21
Troubleshooting	21
<b>SPECIFICATIONS</b>	<b>22</b>
<b>TRAINING TOOLS</b>	<b>23</b>
Attachment 1: FORA MD Blood Glucose Monitoring System Training Checklist	23
Attachment 2: FORA MD Blood Glucose Monitoring System Training Quiz	24
Attachment 3: FORA MD Blood Glucose Monitoring System Quality Control Results Record	25
Notes	26

# IMPORTANT SAFETY PRECAUTIONS

## READ BEFORE USE

Users need to adhere to Standard Precautions when handling or using this device. All parts of the glucose monitoring system should be considered potentially infectious and are capable of transmitting bloodborne pathogens between patients and healthcare professionals. For more information, refer to “Guideline for Isolation Precautions: Preventing Transmission of Infectious Agents in Healthcare Settings 2007”, <http://www.cdc.gov/hicpac/2007ip/2007isolationprecautions.html>.

- The meter should be disinfected after use on each patient. This Blood Glucose Monitoring System may only be used for testing multiple patients when Standard Precautions and the manufacturer’s disinfection procedures are followed.
  - Only auto-disabling, single-use lancing devices should be used with this device.
1. Use this device **ONLY** for the intended use described in this manual.
  2. **DO NOT** use accessories which are not specified by the manufacturer.
  3. **DO NOT** use the device if it is not working properly or if it is damaged.
  4. **DO NOT** under any circumstances use the device on neonates or infants.
  5. This device does **NOT** serve as a cure for any symptoms or diseases. The data measured is for reference only.
  6. Before using this device to test blood glucose, read all instructions thoroughly and practice the test. Carry out all the quality control checks as directed.
  7. Keep the device and testing equipment away from young children. Small items such as the battery cover, batteries, test strips, lancets and vial caps are choking hazards.

## Interfering Substances

Interfering substances depend on concentration. The interfering substances listed below will have no effect up to the limiting concentration level noted.

Substance	Limiting Concentration (mg/dL)	Therapeutic / Physiological Concentration Range (or Upper Limit) (mg/dL)
Acetaminophen	6.25	0.45 - 3
Ascorbic Acid	5	2
Bilirubin (Unconjugated)	20	0 - 2
Dopamine	1.25	0.03
Levodopa	0.7	0.02 - 0.28
Methyldopa	1.875	0.1 - 0.5
Glutathione Reduced	23	47 - 100 (Intracellular)
Pralidoxime Iodide	5	~10 ( IV Dose 500mg)
Tolazamide	12.5	1.6
Uric Acid	10	.2 - 8
Mannitol	5000	0.0128
Mannose	125	1.15
Xylose	3.125	N/A
*Na-Fluoride/K-Oxalate	< 250	250

\* The NaF/K-oxalate concentration is the standard concentration in a blood collection tube.

**KEEP THESE INSTRUCTIONS IN A SAFE PLACE**

## BEFORE YOU BEGIN

Severe dehydration and excessive water loss may cause readings which are lower than actual values. If the patient is suffering from severe dehydration, consult a healthcare professional immediately.

- If the patient's blood glucose results are lower or higher than usual, and does not have any symptoms of illness, first repeat the test. If the patient has symptoms or continues to get results which are higher or lower than usual, follow the treatment advice of a healthcare professional.
- Use only fresh whole blood samples to test patient's blood glucose. Using other substances will lead to incorrect results.
- If the patient has symptoms that are inconsistent with the blood glucose test results and you have followed all the instructions given in this owner's manual, contact a healthcare professional.
- We do not recommend using this product on severely hypotensive individuals or patients in shock. Readings which are lower than actual values may occur for individuals experiencing a hyperglycemic-hyperosmolar state, with or without ketosis. Please consult a healthcare professional before use.

## INTENDED USE

This system is intended to be used for the quantitative measurement of glucose (sugar) in fresh whole blood samples (from the finger). This system is intended for multiple-patient use in professional healthcare settings as an aid to monitor the effectiveness of diabetes control.

It should not be used for the diagnosis of diabetes, or testing on neonates.

## TEST PRINCIPLE

Your system measures the amount of sugar (glucose) in whole blood. The glucose testing is based on the measurement of electrical current generated by the reaction of glucose with the reagent of the strip. The meter measures the current, calculates the blood glucose level, and displays the result. The strength of the current produced by the reaction depends on the amount of glucose in the blood sample.

This system uses enzyme of FAD-dependent glucose dehydrogenase (FAD-GDH) from *E. coli*.



# METER OVERVIEW

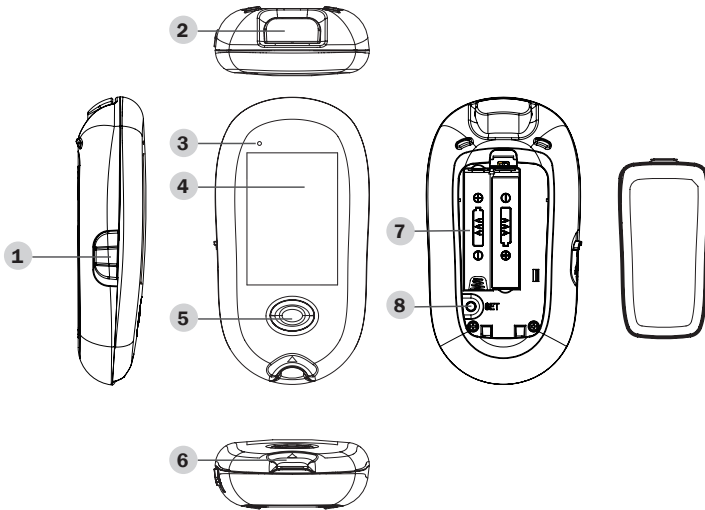

# Display Screen

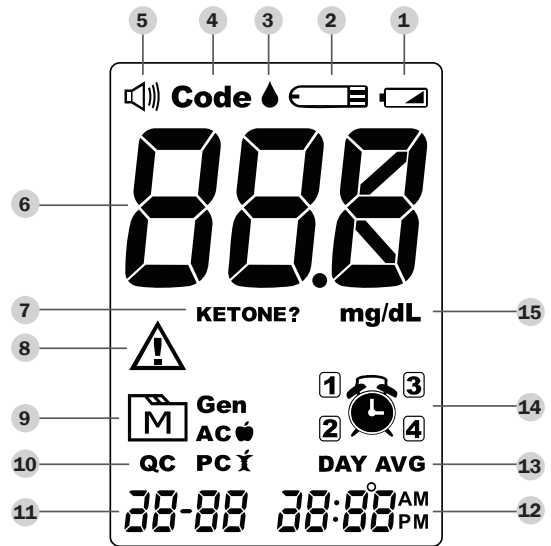

- 1 Bluetooth Switch**  
Activates the Bluetooth function.
- 2 Test Strip Ejector**  
Eject the used strip by pushing up this button.
- 3 Bluetooth Indicator**  
Downloads test results with a Bluetooth connection.
- 4 Display Screen**
- 5 M Button**
- 6 Test Slot with Strip Indication Light**  
Insert test strip here to turn the meter on for testing.
- 7 Battery Compartment**
- 8 SET Button**  
Enter SET mode and confirm the meter settings.

- 1 Low Battery Symbol**
- 2 Test Strip Symbol**
- 3 Blood Drop Symbol**
- 4 Code**
- 5 Volume Symbol**
- 6 Test Result**
- 7 Ketone Warning**
- 8 Error Warning**
- 9 Memory Symbol**
- 10 Measurement Modes**
- 11 Date**
- 12 Time**
- 13 Day Average**
- 14 Reminder Alarms**
- 15 Measurement Unit**

## Test Strip

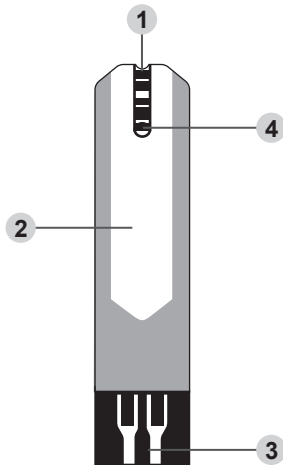

### 1 Absorbent Hole

Touch a drop of blood here, blood will be automatically drawn in.

### 2 Test Strip Handle

Hold this part to insert the test strip into the slot.

### 3 Contact Bars

Insert this end of the test strip into the meter. Push it in firmly until it will go no further.

### 4 Confirmation Window

This is where you confirm if enough blood has been applied to the absorbent hole in the strip.

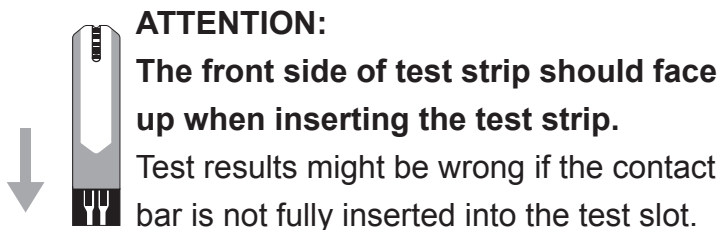

#### ATTENTION:

The front side of test strip should face up when inserting the test strip.

Test results might be wrong if the contact bar is not fully inserted into the test slot.

#### NOTE:

The **FORA MD** meter should only be used with **FORA MD** Test Strips. Using other test strips with this meter can produce inaccurate results.

## Speaking Function

**FORA MD** “speaks” aloud with voice instructions to guide you through the process of blood glucose testing. The following table tells you when and what the meter “says”.

WHEN does the meter talk?	WHAT does the meter say?
<b>Using the meter</b>	
Insert test strip when the meter is ready to test. (symbol appears on display)	1. Thank you for using this product. Please relax during measurement. 2. The Code Number is 10. 3. Please apply blood into the strip.
When the test is completed. (result appears on display)	Your blood glucose is (number) (milligrams per deciliter/millimoles per liter).
When the test result is < 20 mg/dL.	The blood glucose is out of range unable to measure.
When the test result is > 600 mg/dL.	The blood glucose is out of range unable to measure.
Recall the Stored Test Results.	Your blood glucose is (number) (milligrams per deciliter/millimoles per liter).

# Setting the Meter

Before using your meter for the first time or if you change the meter battery, you should check and update these settings. Make sure you complete the steps below and have your desired settings saved.

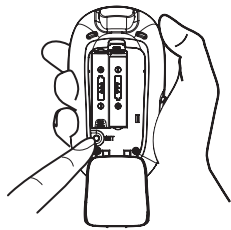

## Entering the Setting Mode

Start with the meter off (no test strip inserted).

Press **SET** to turn on the meter.

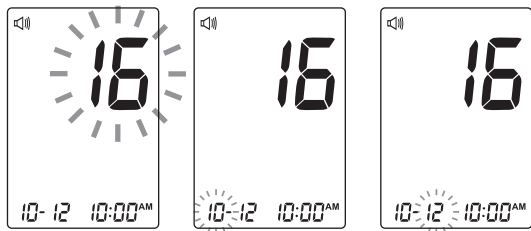

### 1. Setting the date

With the year flashing, press **M** until the correct year appears. Press **SET**.

With the month flashing, press **M** until the correct month appears. Press **SET**.

With the day flashing, press **M** until the correct day appears. Press **SET**.

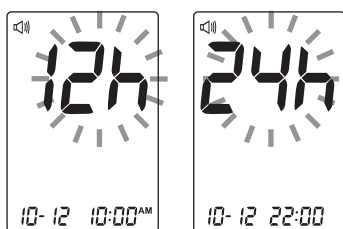

### 2. Setting the time format

Press and release **M** to select the desired time format --- 12h or 24h. Press **SET**.

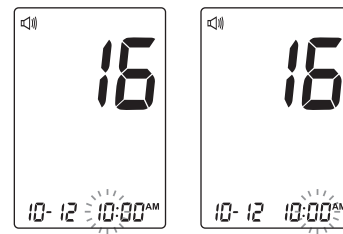

### 3. Setting the time

With the hour flashing, press **M** until the correct hour appears. Press **SET**.

With the minute flashing, press **M** until the correct minute appears. Press **SET**.

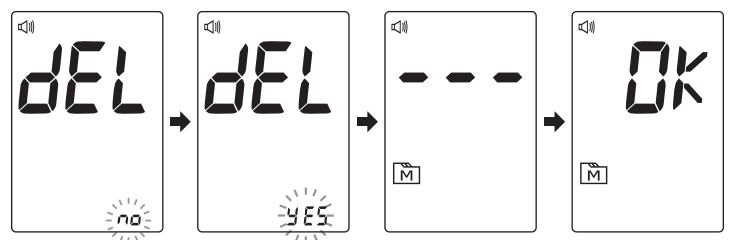



### 4. Deleting the memory

To skip deleting the memory, press **SET** when you see “dEL” and a flashing “no” on the display.

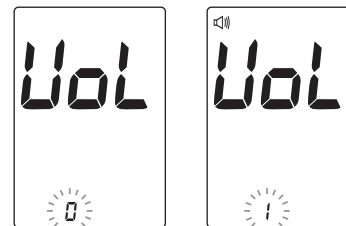
Press **M** to change the “no” to “yES”, and press **SET** to delete all the results.



### 5. Setting the speaking volume

There are seven (7) speaking volume options to choose from. Press **M** until the desired speaking volume appears. To confirm your selection, press **SET**. Volume 0 indicates that the speaking function is turned off, and “” will not display during testing. Volume 1 to 7 indicates speaking volume from low to high, and “” will be displayed throughout the testing.

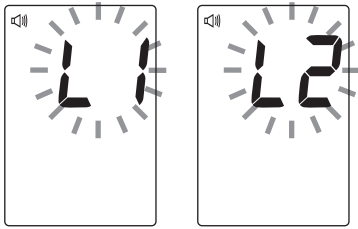

## 6. Choosing a language

Press the **M** button to select L1/L2. The default language for the meter is L1, which is English. To confirm your selection, press SET.

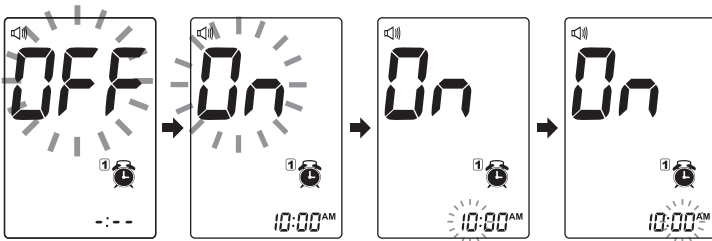

## 7. Setting the reminder alarm

Your meter has four reminder alarms. The meter will display “OFF” and “”. If you don't want to set an alarm, press SET to skip this step. Or press **M** to select "On", then press SET.

With the hour flashing, press **M** to select the correct hour. Press SET.

With the minute flashing, press **M** to select the correct minute. Press SET to confirm and go to the next alarm setting.

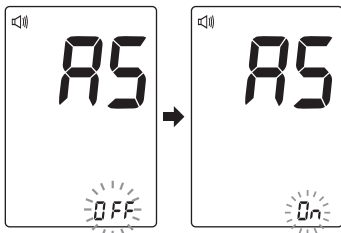

## 8. Setting the Auto-Send

Press **M** to select the auto-send On or OFF. Press SET.

## NOTICE:

This function is referring to the Bluetooth data transmission. If “On” is selected, your result will be transmitted automatically right after the test.

## Congratulations!

## You have completed all settings!

### NOTE:

- These parameters can **ONLY** be changed in the setting mode.
- If the meter is idle for 3 minutes during the setting mode, it will switch off automatically.

## BEFORE TESTING

## Checking the Code Number

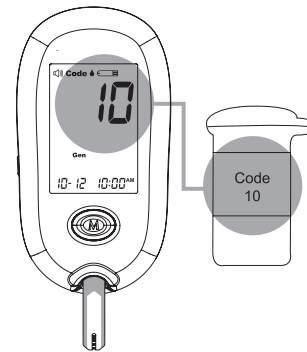

## NOTICE:

The code number on the display is only for your reference, it may not be the actual code for this meter.

### WARNING:

- It is important to make sure that the LCD displayed code is the same as the code on the test strip vial before testing. Failure to do so will get inaccurate results.
- If the LCD displayed code is not the same as the code on the test strip vial, and the code number cannot be updated, please contact Customer Service for assistance.

# Control Solution Testing

Our Control Solution contains a known amount of glucose that reacts with test strips and is used to ensure your meter and test strips are working together correctly.

## Do a control solution test when:

- You first receive the meter (optional)
- Occasionally, once a week is sufficient, to check the meter and test strips for in-range readings
- Every time you open a new container of test strips
- If you drop the meter
- Whenever you get unusual results (high or low)
- **Control solution is NOT used for calibration of the meter.**

## Performing a Control Solution Test

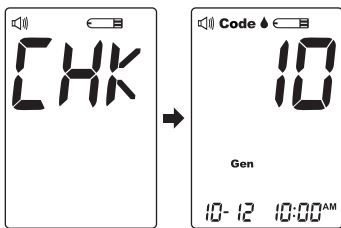

**1. Insert the test strip to turn on the meter**  
Insert the test strip into the meter. Wait for the meter to display the test strip and blood drop symbols.

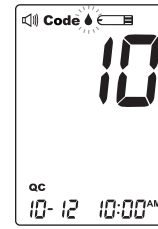

## 2. Press M to mark this test as a control solution test

With “**QC**” displayed, the meter will store your test result in memory under “**QC**”. If you press **M** again, the “**QC**” will disappear and this test is no longer a control solution test.

### WARNING:

When doing the control solution test, you have to mark it so that the test result will not mix with the blood glucose stored in the memory.

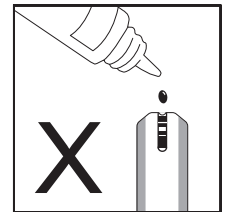
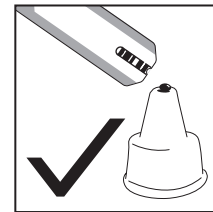
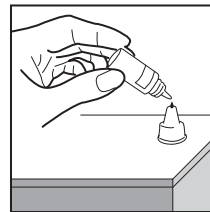

## 3. Apply control solution

Ensure control solution is at room temperature before testing. Shake the control solution vial thoroughly before use. Squeeze out a drop and wipe it off, then squeeze out another drop and place it on the tip of the vial cap.

Hold the meter to move the sample area of the test strip to touch the drop. Once the confirmation window fills completely, the meter will begin counting down.

To avoid contaminating the control solution, do not directly apply control solution onto a strip.

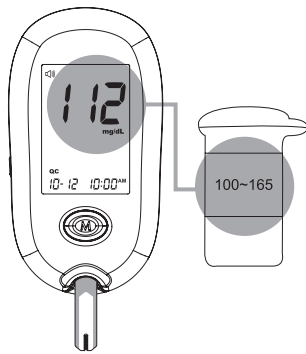

#### 4. Read and compare the result

After counting down to 0, the control solution test result will appear on the display. Compare this result with the range printed on the test strip vial. It should fall within this range. If not, please read the instructions again and repeat the control solution test.

#### Out-of-range results

If you continue to have test results fall outside the range printed on the test strip vial, the meter and/or strips may not be working properly. Do **NOT** test your blood. Contact the local customer service or place of purchase for help.

#### NOTE:

- The control solution range printed on the test strip vial is for control solution use only. It is not a recommended range for your blood glucose level.
- See the **MAINTENANCE** section for important information about your control solutions.

## BLOOD GLUCOSE TESTING

If a single meter is used to test multiple patients, the meter must be cleaned and disinfected using the instructions as specified in this manual after each use, whether or not blood contamination is suspected.

#### Equipment Needed:

1. **FORA MD** Blood Glucose Meter
2. **FORA MD** Test Strips
3. Safety Lancet
4. Gloves
5. Alcohol Wipe or Swab

***Only auto-disabling, single-use lancing devices should be used with this device.***

### Preparing the Puncture Site

We recommend you gently rub the puncture site before puncturing the finger. This will stimulate blood flow and avoid interstitial fluid from affecting the blood sample value.

**Please follow the suggestions below before obtaining a drop of blood:**

- **Wash and dry your hands before starting.**
- Put on a new pair of gloves.
- Select the puncture site.
- Clean the puncture site using cotton moistened with 70% alcohol and **let it air dry.**
- Rub the puncture site.

#### • **Fingertip Testing**

Press the lancing device's tip firmly against the lower side of patient's fingertip.

#### NOTE:

- Choose a different spot each time you test. Repeated punctures at the same spot may cause soreness and calluses.
- It is recommended that you discard the first drop of blood as it might contain tissue fluid, which may affect the test result.
- When cleaning the puncture site, make sure alcohol is thoroughly dry before puncture site is lanced. Testing with alcohol remaining on skin can cause higher results.

# Performing a Blood Glucose Test

Consult manufacturer's instructions for additional information regarding the use of the **FORA MD** Blood Glucose Meter.

1. Verify physician's order.
2. Identify the patient.
3. Explain procedure.
4. Provide privacy.
5. Wash hands.
6. Put on non-sterile gloves.
7. Ensure that the meter and test strips are at room temperature. If there is a temperature change, the meter and test strips should sit at room temperature for 10 to 12 minutes.
8. Verify that the vial of test strips has not expired and/or that the vial has not been opened for longer than 90 days. Discard the vial of test strips if it has expired and/or has been opened for more than 90 days.
9. Cleanse area that is to be punctured with an alcohol swab. Allow area to dry.
10. Insert a test strip in the meter.



**11.** Lightly hold lancet device against the skin and lance the area. Obtain a blood sample (a hanging drop of blood). Do not smear the blood sample as it can affect the test result.

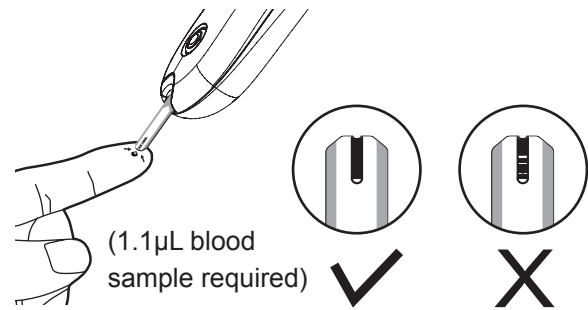

**12.** Make contact with the blood sample to the sample area of the test strip. Blood will be wicked into the test strip and after the confirmation window is filled, the meter will begin counting down.



13. Read the result.
14. Eject the used test strip.
15. Clean and/or disinfect the meter following the cleaning and disinfecting procedures in this manual.
16. Remove gloves and wash hands.

## **NOTE:**

- Do not press the punctured site against the test strip or try to smear the blood.
- If you do not apply a blood sample to the test strip within 3 minutes, the meter will automatically turn off. You must remove and reinsert the test strip to start a new test.
- The confirmation window should be filled with blood before the meter begins to count down. **NEVER** try to add more blood to the test strip after the blood sample has moved away. **Discard the used test strip and retest with a new one.**
- If you have trouble filling the confirmation window, please contact Customer Service at 888-307-8188.

# CLEANING AND DISINFECTION PROCEDURES

## Caring for Your Meter

To avoid the meter and test strips attracting dirt, dust or other contaminants, please wash and dry your hands thoroughly before use.

### ► Why the cleaning and disinfection should be performed

Cleaning and disinfection are different. Cleaning is the process of removing dirt (e.g. food debris, grease, dust); disinfection is the process of killing germs (e.g. bacteria and viruses).

### ► When to clean and disinfect the meter

Clean the meter when you see any dirt on it. You should disinfect the meter at least once a week to prevent infection.

### ► How to clean and disinfect the meter

The meter must be cleaned prior to the disinfection. Use one disinfecting wipe to clean exposed surfaces of the meter thoroughly and remove any visible dirt or blood or any other body fluid with the wipe. Use a second wipe to disinfect the meter. Do **NOT** use organic solvents to clean the meter.

We recommend for meter cleaning and disinfection you should use the disinfecting wipes/towelettes from below. The following product has been shown to be safe for use with the **FORA MD** Blood Glucose Monitoring System.

► Micro-Kill+™ (Micro-Kill Plus™) Medline (EPA Reg. No. 59894-10-37549)

To obtain disinfecting wipes and other information, please contact Medline at 1-800-MEDLINE (1-800-633-5463) or visit [www.medline.com](http://www.medline.com)

### ► Disinfecting Procedures



1. Put on non-sterile gloves.
2. Take out one disinfecting wipe from the package and squeeze out any excess liquid in order to prevent damage to the meter.
3. Wipe all meter's exterior surface display and buttons. Hold the meter with the test strip slot pointing down and wipe the area around the test slot but be careful not to allow excess liquid to get inside. Keep meter wet with disinfection solution contained in the wipe for a minimum of 2 minutes for Micro-Kill+™ wipes. Follow the instructions on the package label of disinfecting wipe. Use two or more wipes if necessary.
4. Remove the wipe. Allow the meter surface to dry completely.
5. Discard the used wipes and never reuse them.
6. Remove and discard gloves in appropriate receptacles and wash hands.



Each cleaning and disinfection cycle includes a pre-cleaning step with one wipe and a disinfection step with a second wipe.

This device has been validated to withstand 10,950 cleaning and disinfection cycles using the recommended disinfecting wipe/towelette.

The tested number of cycles is estimated by 10 cleaning and 37 disinfection cycles per day over 3 years, the expected life of device. The meter should be replaced after the validated number of cleaning and disinfection cycles or the warranty period, whichever comes first.

Improper system cleaning and disinfection may result in meter malfunction.

Stop using the meter if you see any signs of deterioration. For example:

- meter cannot be turned on,
- LCD display cracks or becomes cloudy,
- buttons no longer function,
- meter outer casing cracks,
- data cannot be transmitted to PC,
- color or paint/printing on housing is abnormal,  
or
- scratches or abrasions on meter are higher than acceptable.

Please contact the customer service for a replacement meter if any of the signs of deterioration are noticed.

For more information regarding the risk of transmission of bloodborne pathogens, please refer to:

- “FDA Public Health Notification: Use of Fingerstick Devices on More than One Person Poses Risk for Transmitting Bloodborne Pathogens: Initial Communication” (2010)  
<http://wayback.archive-it.org/7993/20170111013014/http://www.fda.gov/MedicalDevices/Safety/AlertsandNotices/ucm224025.htm>
- “CDC Clinical Reminder: Use of Fingerstick Devices on More than One Person Poses Risk for Transmitting Bloodborne Pathogens” (2010)  
<http://www.cdc.gov/injectionsafety/Fingerstick-DevicesBGM.html>

**NOTE:**

- Do NOT clean and disinfect the meter while performing tests.
- If the meter is being operated by a second person, the meter and lancing device should be decontaminated prior to use by the second person.
- Do NOT allow cleaning and disinfecting solution to get in the test slot, battery compartment, or strip-ejection button.
- If you do get moisture in the test strip slot, wipe it away with a corner of tissue.
- Always dry the meter thoroughly before using it.
- Do not spray the meter directly with cleaning solutions especially those containing water (i.e. soapy water), as this could cause the solution to enter the case inside and damage the electronic components or circuitry.

# METER MEMORY

The meter stores the 1000 most recent blood glucose test results along with respective dates and times in its memory. To enter the meter memory, **start with the meter switched off.**

## Reviewing Test Results

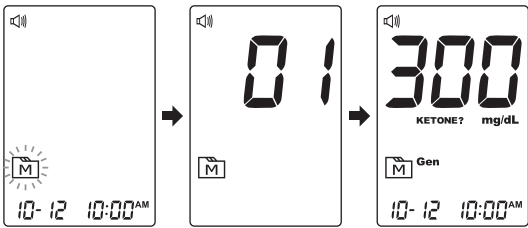

### 1. Press and release M

“M” will appear on the display. Press **M** again, and the first reading you see is the last blood glucose result along with date, time and the measurement mode.  
(300 mg/dL)

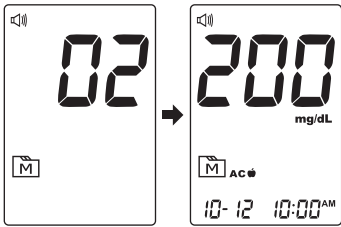

**2. Press M** to recall the test results stored in the meter each time you press. **After the last test results, press M again and the meter will be turned off.**  
(200 mg/dL)

**3. Exit the meter memory.** After the last test result, press **M** again and the meter will be turned off.

## Reviewing Blood Glucose Day Average Results

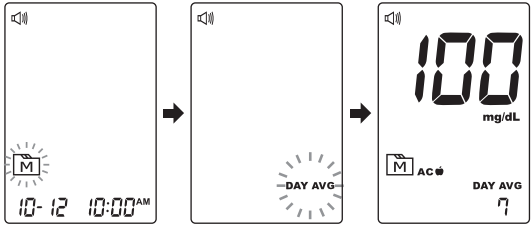

### 1. Press and release M

When “M” appears on the display, keep pressing Main button for 3 seconds until the flashing “**DAY AVG**” appears. Release Main button and then your 7-day average result measured in general mode will appear on the display.

**2. Press M** to review 14-, 21-, 28-, 60- and 90-day average results stored in each measuring mode in the order of Gen, AC, then PC.

**3. Exit the meter memory.** Keep pressing Main button and the meter will turn off after displaying the last test result.

**NOTE:**

- Any time you wish to exit the memory, keep pressing **M** for 5 seconds or leave it without any action for 3 minutes. The meter will switch off automatically.
- Control solution results are **NOT** included in the day average.
- If using the meter for the first time, “---” displays when you recall the test results or review the average result. It indicates that there is no test result in the memory.

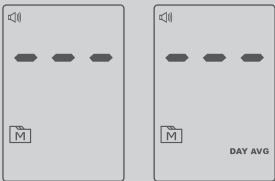

# MAINTENANCE

## Battery

Your meter comes with two 1.5V AAA size alkaline batteries.

### Low Battery Signal

The meter will display one of the messages below to alert you when the meter power is getting low.

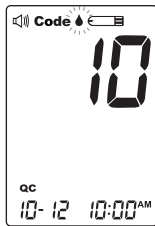

1. The “” appears along with display messages: The meter is functional and the result remains accurate, but it is time to change the batteries.



2. The “” appears with E-b, Error and LOW: The power is not enough to do a test. Please change the batteries immediately.

## Replacing the Battery

To replace the battery, make sure that the meter is turned off.

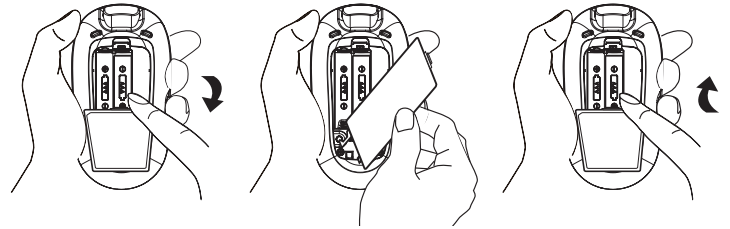

1. Press the edge of the battery cover and lift it up to remove.

2. Remove the old batteries and replace with two 1.5V AAA alkaline batteries.

3. Close the battery cover. If the batteries are inserted correctly, you will hear a “beep” afterwards.

### NOTE:

- Replacing the batteries does not affect the test results stored in the memory.
- As with all small batteries, these batteries should be kept away from small children. If swallowed, promptly seek medical assistance.
- Batteries might leak chemicals if unused for a long time. Remove the batteries if you are not going to use the device for an extended period (i.e., 3 months or more).
- Properly dispose of the batteries according to your local environmental regulations.
- After replacing the batteries, the meter will enter the setting mode.

## Meter Storage

- Storage conditions: -4°F to 140°F (-2°C to 6°C), below 95% relative humidity.
- Always store or transport the meter in its original storage case.
- Avoid dropping and heavy impact.
- Avoid direct sunlight and high humidity.

## Important Test Strip Information

- Storage conditions: 35.6°F to 89.6°F (2°C to 32°C), below 85% relative humidity. Do not freeze.
- Store your test strips in their original vial only.
- Do not transfer to another container.
- Store test strip packages in a cool dry place. Keep away from direct sunlight and heat.
- After removing a test strip from the vial, immediately close the vial cap tightly.
- Touch the test strip with clean and dry hands.
- Same bullet as immediately above. Delete.
- Use each test strip immediately after removing from the vial.
- Write the opening date on the vial label when you first open it. Discard remaining test strips after 3 months (90 days).
- Do not use test strips beyond the expiration date. This may cause inaccurate results.
- Do not bend, cut, or alter a test strip in any way.
- Keep the strip vial away from children. The cap and the test strip may be a choking hazard. If swallowed, promptly seek medical attention.

For further information, please refer to the test strip package insert.



## Important Control Solution Information

- Use only FORA control solutions with your meter.
- Do not use the control solution beyond the expiration date or 3 months after first opening. Write the opening date on the control solution vial and discard the remaining solution after 3 months.
- It is recommended that the control solution test be done at room temperature (68°F to 77°F) 20°C to 25°C. Make sure your control solution, meter, and test strips are at this specified temperature range before testing.
- Store the control solution tightly closed at temperatures between 36°F and 86°F (2°C and 30°C). **DO NOT FREEZE.**







# SYSTEM TROUBLESHOOTING

If you follow the recommended action but the problem persists, or error messages other than the ones below appear, please call your local customer service. Do not attempt to repair yourself and never try to disassemble the meter under any circumstances.

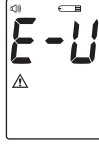
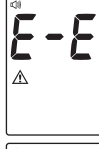
## Result Readings

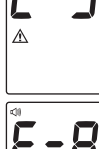
MESSAGE	WHAT IT MEANS
	Appears when your result is below measurement limit, which is less than 20 mg/dL (1.1 mmol/L).
	Appears when your result is equal to or higher than 240 mg/dL (13.3 mmol/L). This indicates the possibility of ketone accumulation for type 1 diabetes. Please seek medical assistance immediately.
	Appears when your result is higher than the limit of measurement, which is higher than 600 mg/dL (33.3 mmol/L).

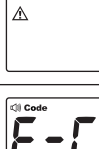
## Error Messages

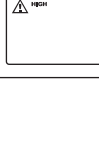
MESSAGE	WHAT IT MEANS	WHAT TO DO
	Appears when the batteries cannot provide enough power for a test.	Replace the batteries immediately.
	Appears when a used test strip is inserted.	Repeat the test with a new test strip.
	Problem in operation.	Repeat the test with a new test strip. If the meter still does not work, please contact customer service for assistance.
		
		
		
	Appears when test strip is removed while counting down.	Repeat the test with a new test strip.
	Appears when coding is the error.	Check if the code numbers on the display and the strip vial are the same.
	Appears when ambient temperature is below system operation range.	System operation range is 50°F to 104°F (10°C to 40°C). Repeat the test after the meter and test strip are in the above temperature range.
	Appears when ambient temperature is above system operation range.	

## Troubleshooting

1. If the meter does not display a message after inserting a test strip:

POSSIBLE CAUSE	WHAT TO DO
Battery exhausted.	Replace the battery.
Test strip inserted upside down or incompletely.	Insert the test strip with contact bars end first and facing up.
Defective meter or test strips.	Please contact customer service.

2. If the test does not start after applying the sample:

POSSIBLE CAUSE	WHAT TO DO
Defective test strip.	Repeat the test with a new test strip.
Sample applied after automatic switch-off (3 minutes after last user action).	Repeat the test with a new test strip. Apply sample only when flashing “  ” appears on the display.
Defective meter.	Please contact customer service.

3. If the control solution testing result is out of range:

POSSIBLE CAUSE	WHAT TO DO
Error in performing the test.	Read instructions thoroughly and repeat the test again.
Control solution vial was poorly shaken.	Shake the control solution vigorously and repeat the test again.
Expired or contaminated control solution.	Check the expiration date of the control solution.
Control solution that is too warm or too cold.	Control solution, meter, and test strips should be at room temperature 68°F to 77°F (20°C to 25°C) before testing.
Defective test strip.	Repeat the test with a new test strip.
Meter malfunction.	Please contact customer service.

## SPECIFICATIONS

**Model No.:** FORA MD

**Dimension & Weight:**

110 (L) x 57 (W) x 25 (H) mm, 71 g

**Power Source:** Two 1.5V AAA alkaline batteries

**Display:** LCD

**Memory:**

1000 measurement results with respective date and time

**External Output:** Bluetooth

Auto electrode insertion detection

Auto reaction time countdown

Auto switch off after 3 minutes without action

Temperature Warning

**Operating Condition:**

50°F to 104°F (10°C to 40°C), 10% to 85% R.H. (no condensing)

**Storage/Transportation Conditions:**

-4°F to 140°F (-20°C to 60°C), below 95% R.H.

**Measurement Units:** fixed mg/dL

**Measurement Range:**

20 to 600 mg/dL (1.1 to 33.3 mmol/L)

This device has been tested to meet the electrical and safety requirements of: IEC/EN 61010-1, IEC/EN 61010-2-101, EN 61326-1, IEC/EN 61326-2-6.

# TRAINING TOOLS

## Attachment 1: FORA MD Blood Glucose Monitoring System Training Checklist

Use the following checklist to assess the trainee's understanding and knowledge of the following areas:

	TASK	(✓)
AREA	CLINICAL USE OF DEVICE	
Knowledge	Knows key features of <b>FORA MD</b> meter.	
	Understands different test types - finger, quality control, preferred sample type and sample volume.	
	Principles of quality testing and QC materials.	
	Only uses <b>FORA MD</b> test strips and <b>FORA</b> control solution with the <b>FORA MD</b> meter.	
	Understands the important features, benefits and limitations of the <b>FORA MD</b> system.	
	Knows the proper method of disposing of used test strips, lancet and gloves according to facility procedures.	
	Understands the displayed error messages and corresponding actions to take.	
	Understands the appropriate steps to take for troubleshooting.	
	Knows the actions to be taken when the results are abnormally high or low.	
	Understands the information required to be documented by law and by institution.	
Equipment	Identify the essential equipment used with the <b>FORA MD</b> system.	
	Locates the serial number, test strip port, test strip ejector, M and SET buttons on the meter.	
	Locates the expiration date, first opening date, lot number and control solution ranges on the test strip vial. Locates sample area, confirmation window, contact bars and test strip handle on the test strips.	
	Locates the expiration date, first opening date and lot number on the control solution bottle.	
	Knows the proper storage conditions of the meter, test strips and control solutions.	
	Knows how to maintain the meter.	
Practical	Demonstrates proper safety lancet technique when collecting a blood sample.	
	Demonstrates the correct blood testing procedures using the <b>FORA MD</b> Blood Glucose Monitoring System.	
	Demonstrates the correct test strip insertion technique.	
	Performs quality control tests at specific times and determines if the results are acceptable. Takes appropriate action if there is a problem.	
	Demonstrates the proper cleaning and disinfecting techniques for the <b>FORA MD</b> meter.	
	Performs meter set up, memory retrieval and data transmission operations.	
	Demonstrates the proper actions to take for inaccurate results.	

Training Completed by:

Name of Trainee	Date	Name of Instructor	Signature of Instructor

The trainee must complete the training of the FORA MD Blood Glucose Monitoring System before performing glucose testing on residents.

# Attachment 2: FORA MD Blood Glucose Monitoring System

## Training Quiz

Complete the following questions to assess your understanding about using the FORA MD Blood Glucose Monitoring System to perform blood glucose tests on residents.:

NO.	QUESTIONS	ANSWER
1	The <b>FORA MD</b> Blood Glucose Monitoring System uses: a) GOD (glucose oxidase) enzyme      b) GDH (glucose dehydrogenase) enzyme	
2	The <b>FORA MD</b> Blood Glucose Monitoring System can test samples from: a) Finger      b) AST (Alternative Sites Testing)      c) Control solutions      d) Both A & C	
3	The <b>FORA MD</b> Blood Glucose Monitoring System requires a blood volume of: a) 0.3 $\mu$ L      b) 0.7 $\mu$ L      c) 0.5 $\mu$ L      d) 1.1 $\mu$ L	
4	You should perform a control solution test when: a) You think the meter or test strip may be working incorrectly b) You drop the meter c) You have repeated a test and the test result is still lower or higher than expected d) All of the above	
5	After the control solution and test strip vials have been opened, when do you discard the remaining materials? a) 30 days      b) 90 days      c) 6 months      d) 1 year	
6	When performing a quality control test, how do you apply the control solution onto the test strip? a) Place a drop directly onto the test strip b) Place a drop on a clean surface and then contact the drop with the test strip c) Place a drop on your finger and then contact the drop with the test strip d) Shake the control solution vial and squeeze out a drop onto the tip of the vial cap, then touch test strip to drop	
7	When do you clean and disinfect the meter? a) After each use      b) Daily      c) Weekly      d) Monthly	
8	If you saw the following message on the meter's display, what action should you take?  a) Replace the battery b) Retest with a new strip c) Repeat the test when the room temperature is within 50°F to 104°F	
9	The test strips should be stored: a) At 35.6°F to 89.6°F (2°C to 32°C), below 85% humidity b) At -4°F to 140°F (-20°C to 60°C), below 95% humidity c) In the freezer d) In a different container than the original vial	

Training Completed by:

Name of Trainee	Date	SCORE

Answers:

- 1.(b) 2.(d) 3.(d) 4.(d) 5.(b)  
6.(d) 7.(a) 8.(a) 9.(b)









**FORA<sup>®</sup> MD**

**Distributed by ForaCare, Inc.**

893 Patriot Dr., Suite D, Moorpark, CA 93021 USA

**Products made in Taiwan**

**Toll Free : 1-888-307-8188** (8:30 am - 5:00 pm PST, Mon.-Fri.)

[www.foracare.com](http://www.foracare.com)